



385C
385C L
Hydraulic Excavators

CAT[®]

Cat[®] C18 Diesel Engine with ACERT[®] Technology

Net Power (ISO 9249) at 1800 rpm 390 kW/530 hp

**Operating Weight with 7.25 m ME boom,
2.9 m stick, 5.2 m³ rock bucket**

385C with 650 mm shoes 84 130 kg

385C L with 750 mm shoes 86 550 kg

Maximum Travel Speed 4.4 km/h

Maximum Drawbar Pull 592 kN

385C and 385C L Hydraulic Excavators

High performance and rugged durability combine to maximize your productivity.

Engine

- ✓ The Cat® C18 engine has state-of-the-art ACERT® technology to meet emission regulations with exceptional performance capabilities, fuel efficiency and proven reliability. **pg. 4**

Environmentally Responsible Design

- ✓ Quieter operation, lower engine emissions, less fluid disposal and cleaner service can help you meet or exceed worldwide regulations and protect the environment. **pg. 4**

SmartBoom™

More productive. Faster cycle times for truck loading and rock scraping. Maintains optimum hammering frequency for effective, steady productivity. **pg. 9**

Application and System Match

The 385C and 385C L are designed for tough applications. They are optimally matched to load the Cat 771D and 773E trucks. **pg. 5**

Hydraulics

Proportional Priority Pressure Compensated (PPPC) system with state-of-the-art electronic control ensures hydraulic system efficiency and excellent productivity. **pg. 5**

Electronic Control System

- ✓ ADEM™ A4 maximizes fuel efficiency and performance by maintaining the optimum balance between engine speed and hydraulic demand. **pg. 7**

Operator Station

- ✓ An all-new cab provides improved visibility and comfort. The new monitor is a full-color graphical display with enhanced functionality to provide simple, comprehensive machine interface. **pg. 6**

High level of sustained production, mass excavation and truck loading performance, improved reliability and durability increase your productivity and lower your operating costs.

✓ *New feature*



Booms, Sticks and Linkage

- ✓ Caterpillar excavator booms and sticks are built for performance and long service life. Three types of booms and five sticks are available, offering a range of configurations suitable for a wide variety of applications. All booms and sticks are stress relieved. **pg. 11**

Undercarriage

- ✓ Cat designed excavator undercarriage is stable, durable and low maintenance. The undercarriage is a long, variable gauge type for good machine stability and transportability. **pg. 8**

Structures

- ✓ Caterpillar design and manufacturing techniques assure outstanding durability and service life from these important components and using thicker plates at the boom foot area to improve rigidity. **pg. 9**

Buckets, Quick Coupler, Work Tools

- ✓ A variety of work tools, including buckets, couplers, hammers, crushers, pulverizers, multiprocessors, shears and grapples are available through Cat Work Tools. **pg. 12**

Service and Maintenance

Fast, easy service has been designed in with extended service intervals, advanced filtration, convenient filter access and user-friendly electronic diagnostics for increased productivity and reduced maintenance costs. **pg. 10**

Complete Customer Support

Your Cat dealer offers a wide range of services that can be set up under a customer support agreement when you purchase your equipment. The dealer will help you choose a plan that can cover everything from machine and attachment selection to replacement. **pg. 10**



Engine

A combination of innovations working at the point of combustion, ACERT technology optimizes engine performance while meeting Stage IIIA emission regulations.



Diesel Engine. The Caterpillar C18, with ACERT technology, is a 18.1 liter, six-cylinder, 390 kW (530 hp) engine with mechanically actuated electronic fuel injection (MEUI) and overhead camshaft. ACERT technology provides outstanding engine performance through advanced electronic control, precision fuel delivery, and refined air management.

Fuel Consumption. ADEM A4 controller uses sensors throughout the engine to manage engine load and performance. The ADEM A4 controller is the muscle behind engine responsiveness, self-diagnostics, controlling emissions, and fuel economy.

Fuel System. C18 engine uses a mechanically actuated electrically controlled unit injection (MEUI) system. The MEUI system combines high-pressure injection and electronic control in a single compact unit. The electronic unit injector is an integral part of the C18 fuel system. Computerized electronic control provides precise metering and timing of fuel injection.

Cooling System. High capacity, side-by-side cooling system allows operation in ambient temperatures up to 52°C. The Electric Power Control (EPC) controls the fan speed based on coolant temperature and hydraulic oil temperature for optimized cooling.

Turbocharger. The C18 engine uses a water-cooled, center-section wastegated turbocharger for improved performance.

Emissions. ACERT Technology is a differentiated technology that reduces emissions at the point of combustion. The technology capitalizes on proven Caterpillar leadership in three core engine systems: fuel, air and electronics.

Cold Weather Starting Kit.

The kit consists of two additional batteries, heavy-duty harness, large capacity starting motor, and the ether starting aid. With this kit, the excavator has the capability to start at -32°C.

Environmentally Responsible Design

Caterpillar machines not only help you build a better world, they help maintain and preserve the fragile environment.

Outstanding performance.

Many features designed to provide outstanding performance which can mean more work done in a day, less fuel consumption and minimal impact on our environment.

Low exhaust emissions. The Cat C18 diesel engine utilizes unique ACERT technology to meet exhaust emissions regulations while assuring optimum fuel efficiency.

Quiet operation. The hydraulically driven cooling fan is thermostatically controlled, so the fan only runs at the speed necessary to maintain correct system operating temperatures. The result is cool quiet operation with less disturbance to the surrounding environment.

Ozone protection. To help preserve the earth's ozone layer, the air conditioning unit uses only R-134a refrigerant which does not contain harmful chlorofluorocarbons (CFC's).

Fewer leaks and spills. Engine oil and encapsulated hydraulic oil filters are positioned vertically and are easy to reach to minimize spillage. Service intervals are extended to reduce the times fluids are changed and handled. The new hydraulic oil fine filtration system attachment extends the service interval from 2000 to 5000 hours. Compatible with Cat HEES hydraulic bio-oil for ecologically sensitive applications. Finally, the new Cat Extended Life Coolant extends service (up to 6000 h) so there is less need for fluid disposal.

Applications and Systems Match

The 385C and 385C L are designed for tough applications and for matched performance with Cat trucks.

Built for tough applications.

With an operating weight of 81 to 90 metric tons, the 385C and 385C L are the right tools for the job whether truck loading, heavy construction, quarry and mining, as well as demolition and material handling.

Optimum pass match design. Five to six passes under two minutes, matched to the 771D Quarry and the 772/773F Off-Highway trucks, helps to give you maximum systems production at the lowest cost per ton of material moved.

Maximum availability. New standards for durability and reliability help ensure that your loading system has more uptime, operates efficiently and provides lasting value and high resale.

Versatility and flexibility. Three booms and five sticks provide flexibility for a wide range of job conditions in a variety of applications. Systems matching with configuration offers versatility in job set-up whether top loading or same level truck loading.



Hydraulics

Cat hydraulics deliver power and precise control to keep material moving.

PPPC Hydraulics. Load sensing, Proportional Priority Pressure Compensation (PPPC) system, with Caterpillar-developed electronic actuation, provides high efficiency and excellent controllability.

- Cylinder speed is directly related to operator's movement of joystick from feathering to full speed.
- Flow to cylinders during multifunctional operation is directly controlled by the operator and is not dependent on loads.
- Controller reduces pump output to minimum to save power when joysticks are in neutral position.

Main Pumps. Large, heavy-duty main pumps and a separate swing pump provide quick cycle times during multi-function operation.

Heavy Lift Feature. The heavy lift feature is standard and allows lifting of heavy objects with precision.

Biodegradable Hydraulic Oil. Biodegradable hydraulic oil is available as an option.

Reverse Swing Damping Valve. Swing dampening valves reduce swing wag and produce smooth swing stops.

Auxiliary Hydraulic Valve. The auxiliary valve is standard. It is used with optional control arrangements to operate tools such as hammers and shears.

Operator Station

Designed for simple, easy operation and comfort, the 385C and 385C L allow the operator to focus on production.



Cab Design. The workstation has been designed to be spacious, quiet and comfortable for the operator, assuring high productivity throughout the entire workday. Switches are conveniently located for easy access. The new monitor is located to provide excellent visibility and access.

Seat. The seat provides a variety of adjustments, including fore/aft, height and weight to suit the operator. Also included are adjustable armrests and a retractable seat belt. For additional comfort, a new heated air suspension seat is available as an attachment.

Skylight. An enlarged skylight with sunshade provides excellent visibility and good ventilation.

Hydraulic Activation Control Lever. The hydraulic activation control lever deactivates hydraulic functions during engine start-up, and prevents unintentional machine operation.

Climate Control. Positive filtered ventilation with a pressurized cab comes standard. Fresh air or re-circulated air can be selected with a switch on the left console.

Windows. To maximize visibility, all glass is affixed directly to the cab eliminating the use of window frames. Choice of fixed or easy-to-open split front windshield meet operator preference and application conditions.

- 50/50 split front windshield allows both upper and lower portions to be stored in an overhead position.
- 70/30 split front windshield stores the upper portion above the operator. The lower front windshield features a rounded design to maximize downward visibility and improves wiper coverage.
- Both openable versions feature a one-touch action release system.
- The fixed front windshield is available in standard duty laminated glass or high impact resistant laminated glass.

Wipers. Parallelogram wiper, including a washer nozzle is mounted below the cab windshield, optimizes the operator's viewing area and offers continuous and intermittent modes.

Monitor. The compact, full-color, graphical display monitor is new. The monitor has functions to display machine, maintenance, diagnostic and prognostic information. The angle of the monitor can be adjusted to face the operator and prevent sun glare.

Cab Exterior. The exterior design uses thick steel tubing along the bottom perimeter of the cab, improving the resistance of fatigue and vibration. This design allows the FOGS to be bolted directly to the cab, at the factory or as an attachment later, enabling the machine to meet specifications and job site requirements.

Cab Mounts. The cab shell is attached to the frame with viscous rubber cab mounts, which dampen vibrations and sound levels while enhancing operator comfort.

Electronic Control System

Manages the engine and hydraulics for maximum performance.



Consoles. Redesigned consoles feature a simple, functional design to reduce operator fatigue, ease of switch operation and excellent visibility.

Both consoles have attached armrests and allow the height of the armrests to be adjusted.

Standard Cab Equipment. To enhance operator comfort and productivity, the cab includes a lighter, drink holder, coat hook, service meter, literature holder, magazine rack and storage compartment. The cab can be equipped with optional 12 volt converter and up to two 12V-7 amp electrical sockets to provide additional electrical resources.

Machine Security. An optional Machine Security System (MSS) is available from the factory. MSS uses a special Caterpillar key with an embedded electronic chip for controlling unauthorized machine operation.

Product Link. “Product Link Ready” from the factory.

Monitor Display Screen. The monitor is a full color 400x234 pixels Liquid Crystal Display (LCD) graphic display.

The Master Caution Lamp blinks ON and OFF when one of the critical conditions below occurs:

- Engine oil pressure low
- Coolant temperature high
- Hydraulic oil temperature high

Under normal conditions or the default condition, the monitor display screen is divided into four areas; clock and throttle dial, gauge, event display and multi-information display.

Clock and Throttle Dial Display. The clock, throttle dial and gas-station icon with green color are displayed in this area.

Gauge Display. Three analog gauges, fuel level, hydraulic oil temperature and coolant temperature, are displayed in this area.

Event Display. Machine event information is displayed in this area along with the icon and language.

Multi-information Display. This area is reserved for displaying information that is convenient for the operator. The “CAT” logo mark is displayed when no information is available to display.

Operator Gain/Response. This is used to suit the operators preference or application.

- Quicker, for fast response and more production
- Slower, for more precision
- Three preset settings with 21 available settings



Electronic Joysticks. Electronic joysticks provide features not possible with hydraulic pilot valves:

- Eliminate pilot lines in cab for quieter operation
- Adjustable gain/response

Undercarriage

Durable undercarriage absorbs stresses and provides excellent stability.



Undercarriage Components.

Large, Caterpillar designed and built undercarriage components offer heavy-duty performance and durability.

Sealed and Lubricated Rollers.

Track rollers, carrier rollers and idlers are sealed and lubricated for excellent service life.

Idler Guards and Track Guides.

Idler guards and center track guides used to maintain track alignment are standard. Optional two-piece full-length track guiding guards are available for additional protection on steep side slopes.

Travel Motor. Two-speed axial piston hydraulic motors provide the drive power and automatic speed selection when the high-speed position is selected. This enables the machine to automatically change between computer-controlled high and low speeds depending on drawbar-pull requirements.

Final Drives. The final drives are the three-stage reduction planetary type. This design results in a complete drive/brake unit that is compact and delivers excellent performance and reliability.

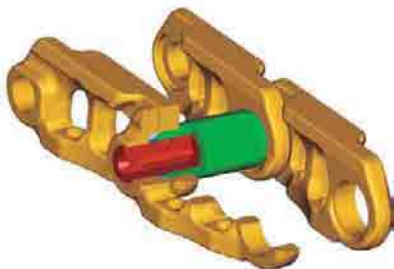

Track. The 385C and 385C L come standard with the new grease lubricated track called GLT4. The track links are assembled and sealed with grease to decrease internal bushing wear, reduce travel noise and extend service life lowering operating costs.

SmartBoom

Reduces stress and vibrations transmitted to the machine.

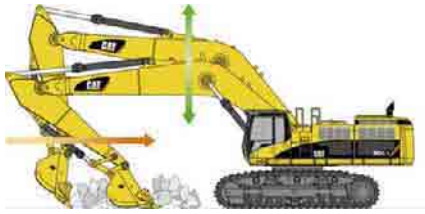

Rock Scraping. Scraping rock and finishing work is easy and fast. SmartBoom simplifies the task and allows the operator to fully concentrate on stick and bucket, while boom freely goes up and down without using pump flow.

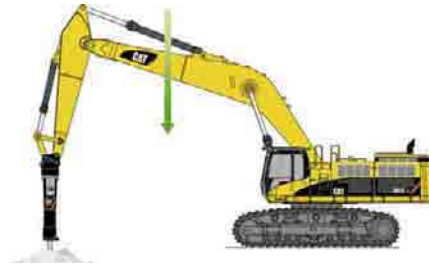

Hammer Work. It has never been this productive and operator-friendly. The front parts automatically follow the hammer while penetrating the rock. Blank shots or excessive force on the hammer are avoided resulting in longer life for the hammer and the machine. Similar advantages are applicable when using vibratory plates.

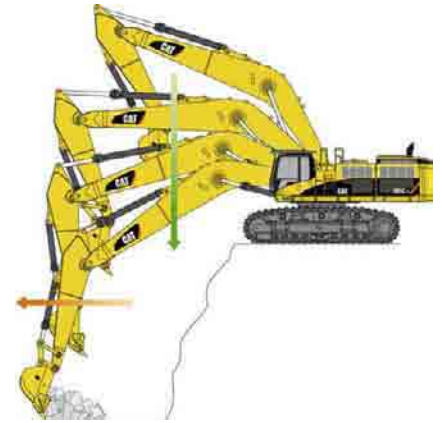

Truck Loading. Loading trucks from a bench is more productive and more fuel efficient as the return cycle is reduced while the boom down function does not require pump flow.

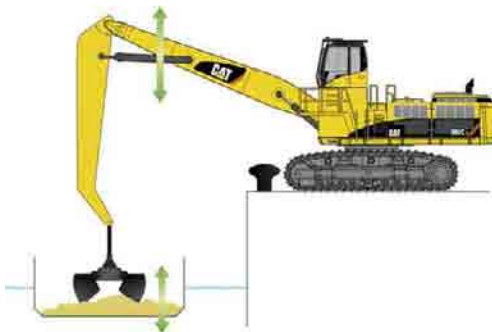

Material Handling. It is more efficient and productive due to faster return cycles. Unloading barges is easier because SmartBoom avoids excessive force being put on the floor of the barge allowing the operator to fully concentrate on production.

Structures

Structural components are the backbone of the machine's durability.

Carbody Design. The advanced carbody design stands up to the toughest applications.

- Modified X-shaped, box-section carbody provides excellent resistance to torsional bending.
- Upper structure weight and stresses are distributed evenly across the full length of the track roller frame.
- Robot welding ensures consistent, high-quality welds throughout the manufacturing process.

Upper Frame. Rugged main frame is designed for maximum durability and efficient use of materials.

- Robot welding for consistent, high-quality welds.
- Outer frame utilizes curved side rails, which are die-formed, for excellent uniformity and strength throughout the length.
- Box section channels improve upper frame rigidity under the cab.
- Boom tower and one piece main rails.
- New boom foot design transfers load more efficiently with less stress in critical areas.
- Reinforced lift cylinder and swing drive mounts increase structure durability in rock and quarry applications.

Track Roller Frames. The track roller frame is made of thick steel plate that is bent into a U-shape and welded to the bottom plate to create a box structure. The box structure design provides increased rigidity and impact resistance.

Variable Gauge Undercarriage.

The variable gauge undercarriage is standard, providing a wide, stable base for operating, or a narrow gauge for reduced shipping width. The track roller frames are bolted to the carbody, and can be placed in two positions.

Service and Maintenance

Fast, easy service has been designed in with extended service intervals, advanced filtration, convenient filter access and user-friendly electronic diagnostics.



Service Intervals. Service intervals are extended to reduce maintenance costs. Engine oil, oil filter and fuel filters at 500 hours.

Oil Sample and Pressure Ports. Oil sample and pressure ports provide easy checking of machine condition and are standard on every machine.

Hydraulic Capsule Filters. The return filters or capsule filters for the hydraulic system are located beside the hydraulic tank. The filter elements are removable without spilling hydraulic oil.

Service Points. Service points are centrally located with easy access to facilitate routine maintenance.

Pilot Hydraulic System Filter. Pilot hydraulic system filter keeps contaminants from the pilot system and is located in the pump compartment.

Remote Greasing Block. A concentrated remote greasing block on the boom delivers grease to hard-to-reach locations.

Radial Seal Cleaner. Radial seal main air cleaner with precleaner has a double-layered filter element for more efficient filtration. No tools are required to change the element.

Fuel-Water Separator. The water separator removes water from fuel, even when under pressure, and water level can be monitored in the cab.

Complete Customer Support

Cat dealer services help you operate longer with lower costs.



Machine Selection. Make detailed comparisons of the machines you are considering before you buy. What are the job requirements, machine attachments and operating hours? What production is needed? Your Cat dealer can provide recommendations.

Purchase. Consider the financing options available as well as day-to-day operating costs. This is also the time to look at dealer services that can be included in the cost of the machine to yield lower equipment owning and operating costs over the long run.

Customer Support Agreements. Cat dealers offer a variety of product support agreements, and work with customers to develop a plan the best meets specific needs. These plans can cover the entire machine, including attachments, to help protect the customer's investment.

Operation. Improving operating techniques can boost your profits. Your cat dealer has videotapes, literature and other ideas to help you increase productivity, and Caterpillar offers certified operator training classes to help maximize the return on your investment.

Product Support. You will find nearly all parts at our dealer parts counter. Cat dealers utilize a worldwide computer network to find in-stock parts to minimize machine downtime. You can save money with Cat remanufactured components.

Maintenance Services. Repair option programs guarantee the cost of repairs up front. Diagnostic programs such as Scheduled Oil Sampling, Coolant Sampling and Technical Analysis help you avoid unscheduled repairs.

Replacement. Repair, rebuild or replace? Your Cat dealer can help you evaluate the cost involved so you can make the right choice.

Booms, Sticks and Linkage

Designed for flexibility, high productivity, and efficiency in a variety of applications.

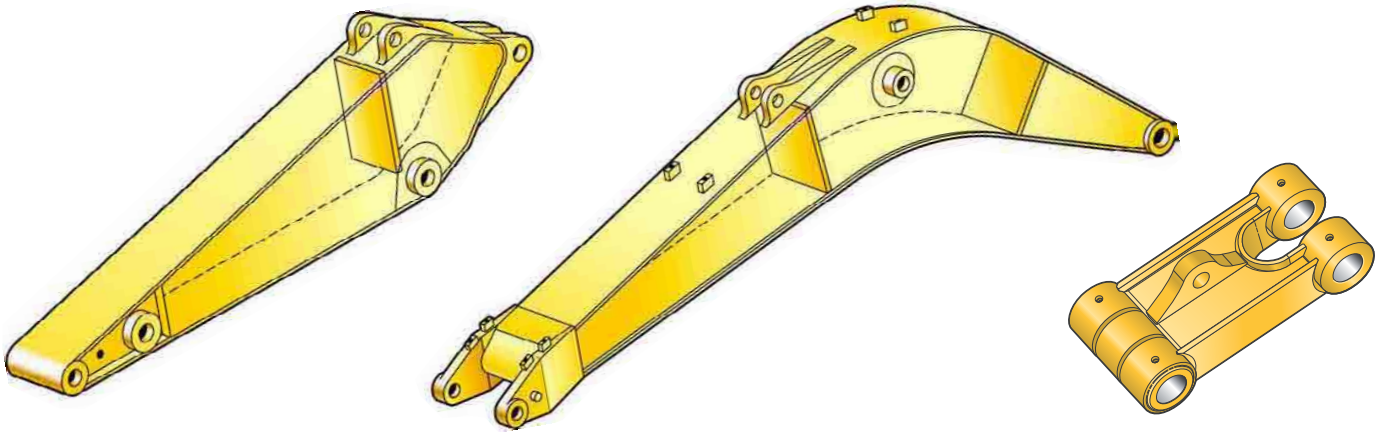

Front Linkage Attachments. Select the right combination of front linkage with your Cat dealer to ensure high productivity from the very start of your job. Three types of booms and five sticks are available, offering a range of configurations suitable for a wide variety of applications and offer a large combination of reach and digging forces for optimum versatility. All booms and sticks undergo a stress relieving process for greater durability.

Boom Construction. The booms have large cross-sections and internal baffle plates to provide long life durability. Castings and forgings are used in critical high-load areas such as the boom nose, boom foot, and boom cylinder connection.

Mass Excavation Boom. The 7.25 m mass boom is most suitable for high production loading where reach and depth are less important. It allows use of the largest buckets. Two sticks are available for this boom.

General Purpose Boom. The 8.4 m GP boom has been designed to balance the reach, digging force and bucket capacity required for a wide range of applications. Three sticks are available for use with the GP boom.

Reach Boom. The 10 m reach boom is for use in deep trenching applications where long reach and depth are necessary. Two long sticks are available for this boom.

Stick Construction. Sticks are made of high-tensile strength steel using a large box section design with interior baffle plates and an additional bottom guard to protect against damage.

Mass Sticks. Two mass excavation sticks are available for higher digging forces and increased bucket capacity.

- **M3.4JB.** The 3400 mm stick provides excellent digging envelope with large bucket capacity and high force levels.
- **M2.9JB.** The 2920 mm stick is intended for mass excavation applications with very large buckets with high force requirements.

General Purpose and Reach Sticks.

Three lengths of GP sticks and two length of reach sticks are available to suite a variety of applications.

- **G/R5.5HB.** The 5500 mm stick gives the largest working envelope and is best suited to narrower buckets.
- **G/R4.4HB.** The 4400 mm stick is ideal for deep trenching and sloping, while providing superior lifting capacity compared to the 5500 mm stick.
- **G3.4JB.** The 3400 mm stick offers the most versatility and is suited to all types of applications and bucket capacities.

Bucket Linkage. Two bucket linkages are available, with or without a lifting eye on the power link.

- The JB bucket linkage is for use with the mass sticks, short GP stick and JB-family buckets
- The HB bucket linkage is for use with longer sticks and HB-family buckets.

Power Link. The new power link improves durability, increases machine-lifting capability in key lifting positions, and is easier to use compared to the previous lift bar design. The power link can be equipped with or without the lifting eye.

Linkage Pins. All pins used in front linkages have thick chrome plating, giving them high wear and corrosion resistance. The large diameter pins smoothly distribute the shear and bending loads to help ensure long pin, boom and stick life.

Buckets, Teeth and Work Tools

A wide variety of buckets help optimize machine performance.

Purpose designed and built to Caterpillar's high durability standards.

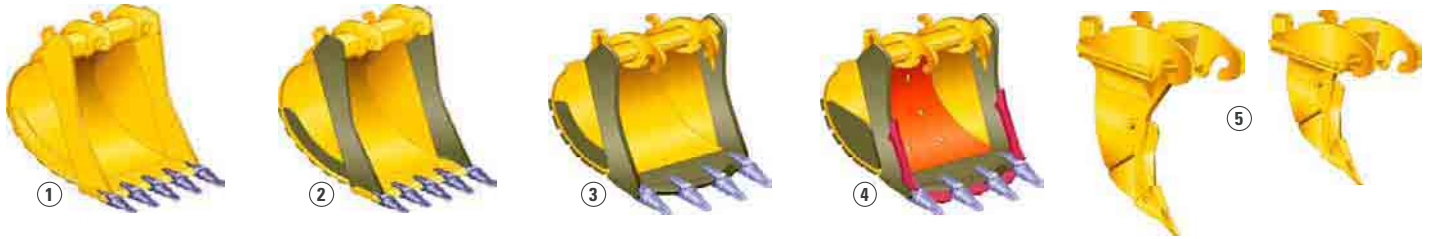

New Caterpillar K Series™ Tooth System



1 Excavation (X). Digs and loads soft to medium materials such as clay and earth. Features weld on tip adapters, hardened cutting edge and side bars.

2 Extreme Excavation (EX). Digs and loads compact/abrasive materials like earth/rock, sand/clay, sand/gravel, coal, chalk and low abrasion ores. Features bigger ground engaging tools, plus abrasion resistant steel for all wear parts.

3 Rock (R). Digs and loads mixed earth/rock soils containing high percentage of rock or other abrasive materials. Features V-spade cutting edge, thicker base and wear surfaces.

4 Heavy Duty Rock (HDR). For aggressive bucket digging and loading in highly abrasive applications such as granite and basalt. Features V-spade cutting edge and extreme wear package.

Differences from rock buckets:

- Highest durability due to extreme wear package;
- Side wear plates are thicker and extend further up to the bucket;
- Inside wear package (liner) made of high strength, 400 Brinell, abrasion resistant steel;
- Standard equipped with sidebar protectors and edge segments to extend bucket lifetime.

Other buckets and teeth are available from Caterpillar for use in quarry, high abrasion, and special applications. Ask your dealer representative to recommend the optimum solution for your material and operation.

5 Ripper. The Caterpillar TR-series rippers are available for use with CW-series quick couplers, or to attach directly to the stick and linkage. The ripper provides a powerful single point of penetration force to break out rock and other difficult to excavate material. In order to break into the toughest ripping applications a short ripper is available. Usage with the quick coupler and a compatible rock bucket facilitates the “Rip & Load” technique to supplement or replace blasting to prepare rock material prior to truck loading.

Quick Couplers. Caterpillar quick couplers enable the operator to simply release one work tool and pick up another. Your hydraulic excavator becomes highly versatile. The dedicated CW-Series quick coupler enables a quick tool exchange while maintaining top machine performance. A lifting hook is added for maximum lift capacity.

Variety of work tools. Choose from a variety of work tools such as hammers, crushers, pulverizers, shears, multiprocessors and grapples. Ask your Cat dealer for information on attachments or special configurations.

K Series Tip Selection. The new Caterpillar K Series Tooth System holds tighter, changes easier and stays sharper.

- 10** General Duty
- 11** Extra Duty
- 12** Penetration
- 13** Penetration Plus
- 14** Heavy Penetration
- 15** Heavy Abrasion
- 16** Wide
- 17** Spike
- 18** Double Spike



Bucket Specifications

Without Quick Coupler	Linkage	Width	Weight*	Capacity (ISO)	Fill Factor	ME boom 7250				General Purpose boom 8400 mm						Reach boom 10 000 mm			
						385C		385C L		385C			385C L			385C		385C L	
						2920 mm	3400 mm	2920 mm	3400 mm	3400 mm	4400 mm	5500 mm	3400 mm	4400 mm	5500 mm	4400 mm	5500 mm	4400 mm	5500 mm
Excavation (X)	HB	1150	2833	2.0	100	×	×	×	×	×			×						
	HB	1350	3073	2.6	100	×	×	×	×	×			×				N		
	HB	1750	3624	3.5	100	×	×	×	×	×			×			N	N	N	N
	HB	1900	3839	4.0	100	×	×	×	×	×			×			N	N	N	N
Extreme Excavation (EX)	JB	1600	4473	3.8	100						×	×		×	×	×	×	×	×
	JB	2150	5484	5.5	100					N	×	×	N	×	×	×	×	×	×
	JB	2250	5634	5.8	100					N	×	×	N	×	×	×	×	×	×
Rock (R)	JB	1900	5464	4.8	90					N	×	×		×	×	×	×	×	×
	JB	2000	5624	5.2	90					N	×	×	N	×	×	×	×	×	×
	JB	2150	5864	5.6	90					N	×	×	N	×	×	×	×	×	×
	JB	2250	6029	6.0	90					N	×	×	N	×	×	×	×	×	×
Heavy Duty Rock (HDR)	JB	1900	6114	4.8	90					N	×	×	N	×	×	×	×	×	×
	JB	2000	6294	5.2	90					N	×	×	N	×	×	×	×	×	×
	JB	2150	6564	5.6	90					N	×	×	N	×	×	×	×	×	×
Maximum load in kg (payload plus bucket)						14209	13257	14696	13718	10359	9725	8412	10755	10089	8742	6851	5917	7169	6209
With Quick Coupler CW-70																			
Excavation	HB	1350	3073	2.6	100	×	×	×	×	×			×			N	N	N	N
Rock (R)	JB	1900	5424	4.8	90					N	×	×	N	×	×	×	×	×	×
	JB	2000	5574	5.2	90					N	×	×	N	×	×	×	×	×	×
	JB	2150	5834	5.6	90					N	×	×	N	×	×	×	×	×	×
Heavy Duty Rock (HDR)	JB	1900	6074	4.8	90					N	×	×	N	×	×	×	×	×	×
	JB	2000	6254	5.2	90					N	×	×	N	×	×	×	×	×	×
Maximum load in kg (payload plus bucket)						12789	11837	13276	12298	8939	8445	7132	9335	8809	7462	5571	4637	5889	4929

* Bucket weight including K series General Duty tip



Max. Material Density
1200 kg/m³



Max. Material Density
1500 kg/m³



Max. Material Density
1800 kg/m³

Work Tools Matching Guide

When choosing between various work tool models that can be installed onto the same machine configuration, consider work tool application, productivity requirements, and durability. Refer to work tool specifications for application recommendations and productivity information.

		Without Quick Coupler							With Quick Coupler CW-70							
		ME boom		General Purpose boom			Reach boom		ME boom		General Purpose boom			Reach boom		
		7250		8400			10 000		7250		8400			10 000		
		JB	JB	JB	HB	HB	HB	HB	JB	JB	JB	HB	HB	HB	HB	
Stick length (mm)		2920	3400	3400	4400	5500	4400	5500	2920	3400	3400	4400	5500	4400	5500	
Ripper	TR-70, TR-70 short						N	N							N	N
Multiprocessor	MP40	CC, CR	N	N	N		N		N	N	N	N		N	N	N
		PS, S	N	N	N		N		N	N	N	N		N	N	N
Crusher	VHC-60	N	N	N					N	N	N		N		N	N
Pulverizer	VHP-60	N	N	N		N			N	N	N	N	N		N	N
Hydraulic Shear	S365B	N	N	N		N			N	N	N		N		N	N
	S385B				N	N		N		N	N	N	N		N	N



360° Working Range



Over the front



N Not recommended



X Not compatible

Engine

Caterpillar C18 ACERT Technology	
Net Power at 1800 rpm	
ISO 9249	390 kW/530 hp
EEC 80/1269	390 kW/530 hp
Bore	145 mm
Stroke	183 mm
Displacement	18.1 liters

- All engine horsepower (hp) are metric including front page.
- The C18 engine meets Stage IIIA emission requirements.
- Net power advertised is the power available at the flywheel when the engine is equipped with fan, air cleaner, muffler, and alternator.
- No engine derating required below 2300 m altitude.

Brakes

Meets the standard ISO 10265:1998

Hydraulic System

Main System	
Maximum flow	980 l/min
Swing System	
Maximum flow	450 l/min
Maximum pressure	
Normal	320 bar
Heavy lift	350 bar
Travel	350 bar
Swing	260 bar
Pilot System	
Maximum flow	90 l/min
Maximum pressure	41 bar
Boom Cylinder	
Bore	210 mm
Stroke	1967 mm
Stick Cylinder	
Bore	220 mm
Stroke	2262 mm
HB Family Bucket Cylinder	
Bore	200 mm
Stroke	1451 mm
JB Family Bucket Cylinder	
Bore	220 mm
Stroke	1586 mm

Sound

Operator Sound

- The operator sound level measured according to the procedures specified in ISO 6394:1998 is 76 dB(A), for cab offered by Caterpillar, when properly installed and maintained and tested with the doors and windows closed.
- Hearing protection may be needed when operating with an open operator station and cab (when not properly maintained or doors/windows open) for extended periods or in noisy environment.

Exterior Sound

- The labeled spectator sound power level measured according to the test procedures and conditions specified in 2000/14/EC is 109 dB(A).

Cab/FOGS

Cab/FOGS meets ISO 10262.

Machine and Major Component Weights

Actual weights and ground pressures will depend on final machine configuration.

	ME boom 7250 mm		General Purpose boom 8400 mm			Reach boom 10 000 mm		
	M2.9JB	M3.4JB	G3.4JB	G/R4.4HB	G/R5.5HB	G/R4.4HB	G/R5.5HB	
Stick type								
Stick length	mm	2920	3400	3400	4400	5500	4400	5500
Bucket weight	kg	5624	5464	4473	3928	3624	3073	2833
Bucket capacity	m ³	5.2	4.8	3.8	4.0	3.5	2.6	2.0
Bucket width/type	mm	2000/R	1900/R	1600/R	1900/R	1750/R	1350/EX	1150/EX
Operating weight – 385C L*								
with 650 mm shoes	kg	85 810	85 780	84 770	83 910	83 920	84 470	84 530
with 750 mm shoes	kg	86 550	86 520	85 510	84 650	84 660	85 210	85 270
with 900 mm shoes	kg	87 660	87 630	86 610	85 760	85 770	86 320	86 380
Ground pressure – 385C L								
with 750 mm shoes	bar	1.04	1.04	1.03	1.02	1.02	1.02	1.02
Stick weight (with bucket cylinder)	kg	4850	4990	4820	4550	4860	4550	4860
Boom weight (with stick cylinder)	kg	8320		8240			9650	
Boom cylinders (pair)	kg	1750						
Upperstructure**	kg	21 450						
Undercarriage – 385C L								
with 650/750/900 mm shoes	kg	32 160 / 32 900 / 34 000						
Counterweight	kg	11 650						

* With counterweight, operator and full fuel. For operating weights with standard undercarriage deduct approx. 1700 kg.

** Without counterweight.

Dimensions

All dimensions are approximate.

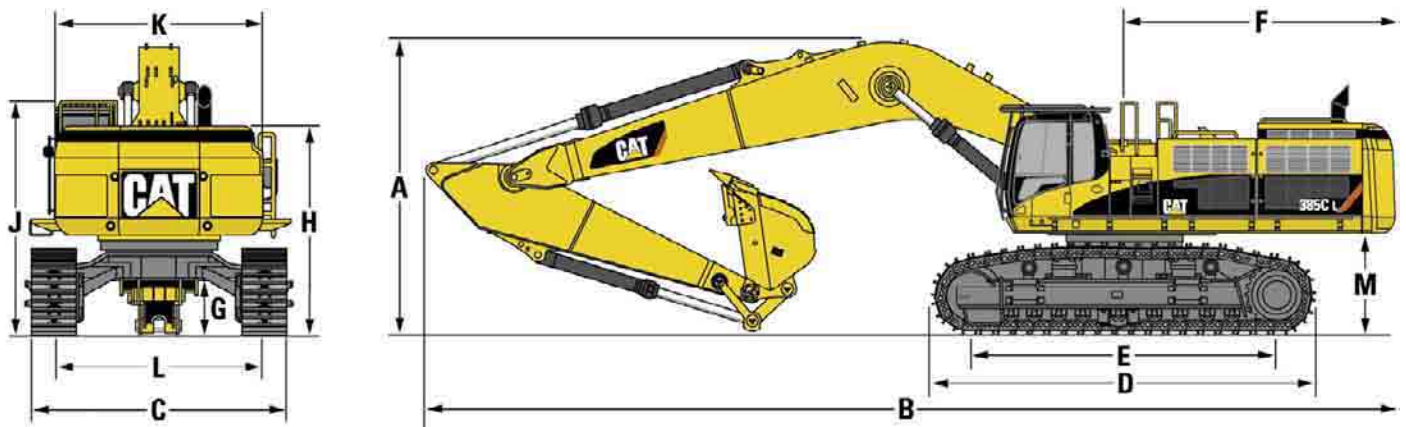

	mm
A Shipping height (with bucket)	
Mass Excavation boom 7250 mm	
2920 mm stick	4782
3400 mm stick	4942
General Purpose boom 8400 mm	
3400 mm stick	4960
4400 mm stick	5146
5500 mm stick	5736
Reach boom 10 000 mm	
4400 mm stick	4937
5500 mm stick	5357

	mm
B Shipping length	
Mass Excavation boom 7250 mm	
2920 mm stick	13 470
3400 mm stick	13 474
General Purpose boom 8400 mm	
3400 mm stick	14 633
4400 mm stick	14 602
5500 mm stick	14 398
Reach boom 10 000 mm	
4400 mm stick	16 233
5500 mm stick	16 171

	mm
C Track width retracted	
650 mm shoes	3400
750 mm shoes	3500
900 mm shoes	3840
D Track length	
385C/385C L	5840/6360
E Length to centers of roller	
385C/385C L	4600/5120
F Tail swing radius	4590
G Ground clearance	890
H Body height	3460
J Cab height	3760
K Body width*	3470
L Track gauge	
extended	3510
retracted	2750
M Counterweight clearance	1580

* No mirrors or handrails

Drive

Maximum Travel Speed	4.4 km/h
Maximum Drawbar Pull	592 kN

Swing Mechanism

Swing Speed	6.5 rpm
Swing Torque	204.5 kNm

Track

385C	
standard	650 mm
optional	750 mm
385C L	
standard	750 mm
optional	650, 900 mm
Number of shoes each side	
385C/385C L	47/51
Number of rollers each side	
385C/385C L	8/9
Number of carrier rollers each side	3

Service Refill Capacities

	Liters
Fuel Tank	1240
Cooling System	101
Engine Oil	65
Swing Drive (each)	19
Final Drive (each)	21
Hydraulic system (including tank)	995
Hydraulic tank	810

Working Ranges – Mass Boom

Mass Excavation (ME) boom configuration (7250 mm)

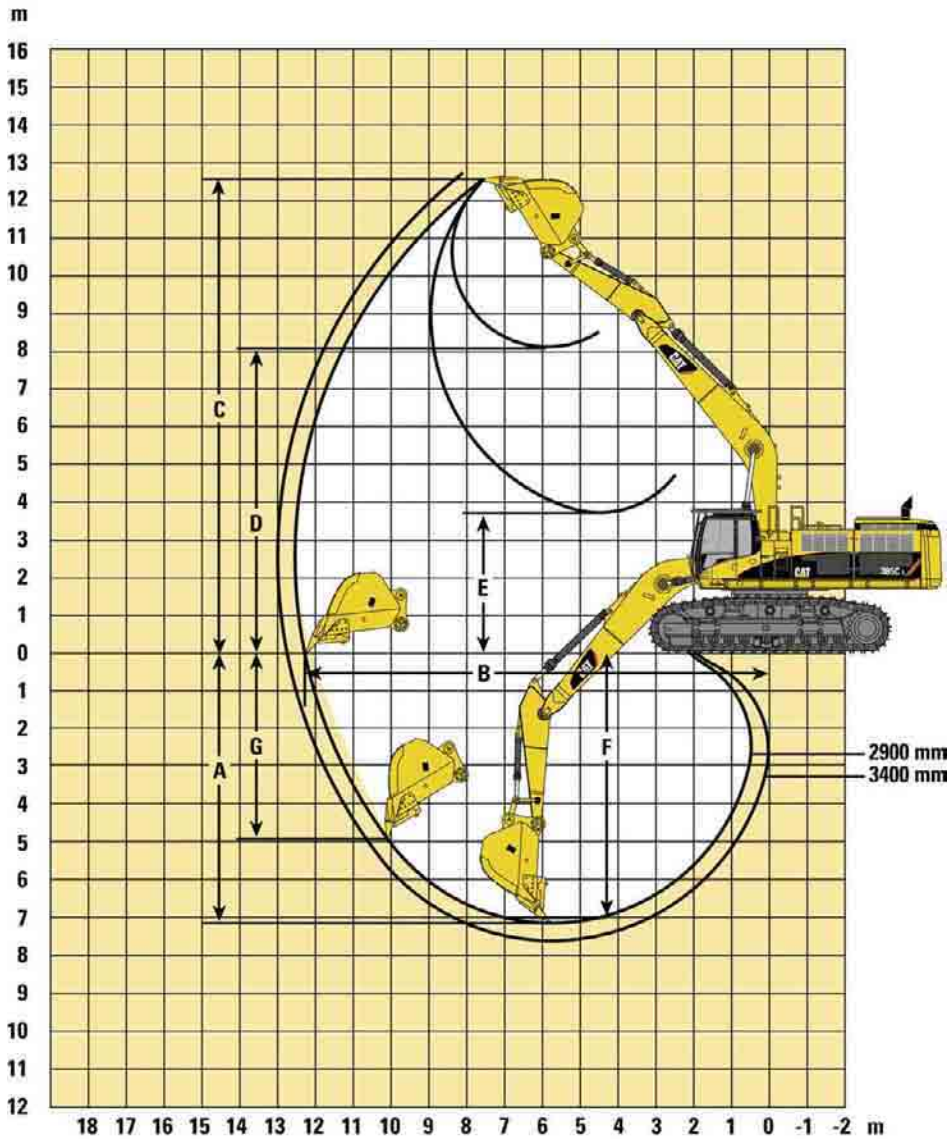

		M2.9JB	M3.4JB
Stick Length	mm	2920	3400
A Maximum Digging Depth	mm	-7140	-7615
B Maximum Reach at Ground Level	mm	12 281	12 704
C Maximum Cutting Height	mm	12 539	12 679
D Maximum Loading Height	mm	8059	8233
E Minimum Loading Height	mm	3706	3232
F Maximum Digging Depth 2.44 m Level Bottom	mm	-6997	-7485
G Maximum Vertical Wall Digging Depth	mm	-4646	-4917
Bucket Capacity	m ³	5.2	5.2
Bucket Radius at Cutting Edge	mm	2233	2233
Bucket digging force (ISO)	kN	394	385
Stick digging force (ISO)	kN	362	344

Lift Capacities – Mass Boom (JB family) 7250 mm

Heavy lift on. All weights are in kg.

















385C

Short Stick
2920 mm

Shoes
650 mm

Bucket Capacity
5.2 m³

Bucket Weight
5430 kg

	3.0 m		4.5 m		6.0 m		7.5 m		9.0 m		10.5 m				m	
																
10.5 m														*7100	*7100	9.02
9.0 m							*17 760	*17 760						*6550	*6550	10.33
7.5 m							*19 630	*19 630	*15 100	14 020				*6360	*6360	11.18
6.0 m					*25 930	*25 930	*21 220	20 390	*18 200	13 960				*6400	*6400	11.71
4.5 m			*42 090	*42 090	*29 570	29 070	*23 140	19 430	18 560	13 560				*6640	*6640	11.96
3.0 m					*32 560	26 920	*24 830	18 380	18 010	13 050	*12 520	9260		*7100	7090	11.98
1.5 m					*33 860	25 380	24 230	17 490	17 500	12 570				*7800	7260	11.74
0 m			*21 360	*21 360	*33 250	24 610	23 620	16 920	17 160	12 240				*8860	7920	11.25
-1.5 m	*18 110	*18 110	*34 640	*34 640	*30 840	24 460	23 410	16 730	17 070	12 160				*10 470	9300	10.46
-3.0 m	*32 570	*32 570	*32 930	*32 930	*26 430	24 820	*20 330	16 920								
-4.5 m			*23 620	*23 620	*19 020	*19 020	*12 530	*12 530								

















385C

Medium Stick
3400 mm

Shoes
650 mm

Bucket Capacity
5.2 m³

Bucket Weight
5430 kg

	3.0 m		4.5 m		6.0 m		7.5 m		9.0 m		10.5 m				m	
																
10.5 m							*11 070	*11 070						*6300	*6300	9.61
9.0 m							*16 100	*16 100						*5830	*5830	10.82
7.5 m							*18 430	*18 430	*15 380	14 400				*5670	*5670	11.63
6.0 m					*24 390	*24 390	*20 190	*20 190	*17 440	14 200				*5720	*5720	12.13
4.5 m			*39 500	*39 500	*28 210	*28 210	*22 250	19 700	*18 530	13 730	13 510	9620		*5960	*5960	12.38
3.0 m					*31 620	27 430	*24 170	18 580	18 130	13 150	13 270	9390		*6390	*6390	12.39
1.5 m			*17 250	*17 250	*33 530	25 700	24 360	17 600	17 550	12 600	13 000	9140		*7070	6650	12.17
0 m			*22 830	*22 830	*33 560	24 710	23 640	16 930	17 120	12 200	12 820	8960		*8070	7200	11.70
-1.5 m	*17 390	*17 390	*33 260	*33 260	*31 770	24 380	23 300	16 620	16 930	12 020				*9590	8350	10.94
-3.0 m	*29 370	*29 370	*35 930	*35 930	*28 060	24 550	*21 610	16 680	15 650	12 150						
-4.5 m			*27 470	*27 470	*21 730	*21 730	*15 780	*15 780								

















385C L

Short Stick
2920 mm

Shoes
750 mm

Bucket Capacity
5.2 m³

Bucket Weight
5430 kg

	3.0 m		4.5 m		6.0 m		7.5 m		9.0 m		10.5 m				m	
																
10.5 m														*7100	*7100	9.02
9.0 m							*17 760	*17 760						*6550	*6550	10.33
7.5 m							*19 630	*19 630	*15 100	14 510				*6360	*6360	11.18
6.0 m					*25 930	*25 930	*21 220	21 000	*18 200	14 440				*6400	*6400	11.71
4.5 m			*42 090	*42 090	*29 070	*29 570	*23 140	20 040	*19 160	14 050				*6640	*6640	11.96
3.0 m					*32 560	27 760	*24 830	18 990	*20 020	13 530	*12 520	9660		*7100	*7100	11.98
1.5 m					*33 860	26 220	*25 770	18 100	*20 430	13 050				*7800	7210	11.74
0 m			*21 360	*21 360	*33 250	25 450	*25 570	17 540	*20 010	12 730				*8860	8290	11.25
-1.5 m	*18 110	*18 110	*34 640	*34 640	*30 840	25 300	*23 950	17 340	*18 220	12 640				*10 470	9700	10.46
-3.0 m	*32 570	*32 570	*32 930	*32 930	*26 430	25 660	*20 330	17 540								
-4.5 m			*23 620	*23 620	*19 020	*19 020	*12 530	*12 530								

















385C L

Medium Stick
3400 mm

Shoes
750 mm

Bucket Capacity
5.2 m³

Bucket Weight
5430 kg

	3.0 m		4.5 m		6.0 m		7.5 m		9.0 m		10.5 m				m	
																
10.5 m							*11 070	*11 070						*6300	*6300	9.61
9.0 m							*16 100	*16 100						*5830	*5830	10.82
7.5 m							*18 430	*18 430	*15 380	14 880				*5670	*5670	11.63
6.0 m					*24 390	*24 390	*20 190	*20 190	*17 440	14 680				*5720	*5720	12.13
4.5 m			*39 500	*39 500	*28 210	*28 210	*22 250	20 310	*18 530	14 210	*13 750	10 020		*5960	*5960	12.38
3.0 m					*31 620	28 270	*24 170	19 200	*19 570	13 640	*16 280	9790		*6390	*6390	12.39
1.5 m			*17 250	*17 250	*33 530	26 540	*25 420	18 220	*20 220	13 090	16 120	9540		*7070	6990	12.17
0 m			*22 830	*22 830	*33 560	25 550	*25 630	17 540	*20 140	12 690	*15 470	9360		*8070	7550	11.7
-1.5 m	*17 390	*17 390	*33 260	*33 260	*31 770	25 210	*24 490	17 230	*18 920	12 510				*9590	8730	10.94
-3.0 m	*29 370	*29 370	*35 930	*35 930	*28 060	25 390	*21 610	17 290	*15 650	12 640						
-4.5 m			*27 470	*27 470	*21 730	*21 730	*15 780	*15 780								



Load Point Height



Load Radius Over Front



Load Radius Over Side



Load at Maximum Reach

* Limited by hydraulic rather than tipping load.

The above loads are in compliance with hydraulic excavator lift capacity ratings standard ISO/DIS 10567, they do not exceed 87% of hydraulic lifting capacity or 75% of tipping capacity. Weight of all lifting accessories must be deducted from the above lifting capacities.

Working Ranges – General Purpose Boom

General Purpose (GP) boom configuration (8400 mm)

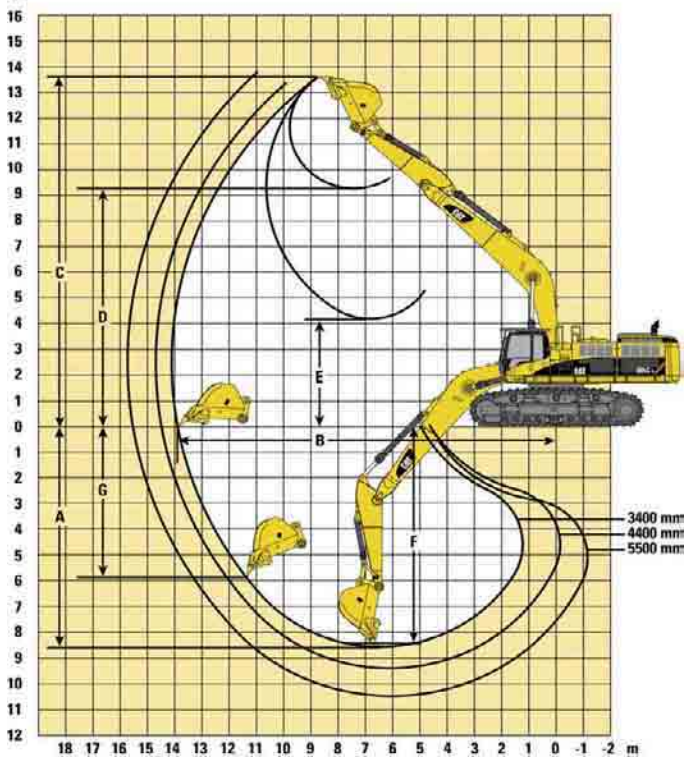

		G3.4JB	G/R4.4HB	G/R5.5HB
Stick Length	mm	3400	4400	5500
A Maximum Digging Depth	mm	-8547	-9403	-10 503
B Maximum Reach at Ground Level	mm	13 808	14 479	15 520
C Maximum Cutting Height	mm	13 579	13 297	13 756
D Maximum Loading Height	mm	9232	9521	9977
E Minimum Loading Height	mm	4163	3299	2199
F Maximum Digging Depth 2.44 m Level Bottom	mm	-8413	-9281	-10 399
G Maximum Vertical Wall Digging Depth	mm	-5874	-5072	-5997
Bucket Capacity	m ³	3.8	3.5	3.5
Bucket Radius at Cutting Edge	mm	2175	1959	1959
Bucket digging force (ISO)	kN	384	334	315
Stick digging force (ISO)	kN	342	293	257

Working Ranges – Reach Boom



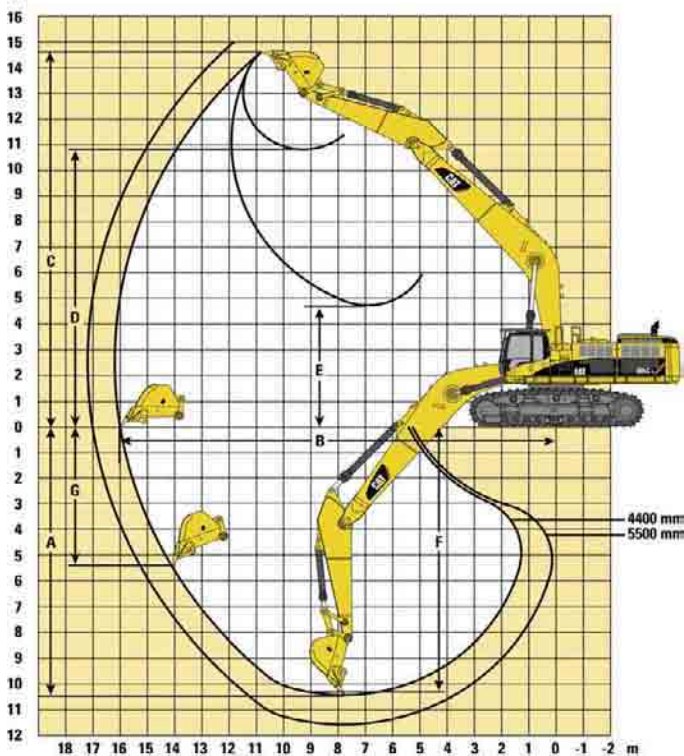

















Reach (R) boom configuration (10 000 mm)











































		G/R4.4HB	G/R5.5HB
Stick Length	mm	4400	5500
A Maximum Digging Depth	mm	-10 451	-11 551
B Maximum Reach at Ground Level	mm	16 015	17 041
C Maximum Cutting Height	mm	14 508	14 939
D Maximum Loading Height	mm	10 777	11 204
E Minimum Loading Height	mm	4681	3584
F Maximum Digging Depth 2.44 m Level Bottom	mm	-10 331	-11 445
G Maximum Vertical Wall Digging Depth	mm	-5367	-6296
Bucket Capacity	m ³	2.6	2.0
Bucket Radius at Cutting Edge	mm	1959	1959
Bucket digging force (ISO)	kN	335	316
Stick digging force (ISO)	kN	293	256

Lift Capacities – General Purpose Boom (JB + HB family) 8400 mm

Heavy lift on. All weights are in kg.

385C Medium Stick – 3400 mm		Shoes – 650 mm				Bucket Capacity – 3.8 m ³				Bucket Weight – 4500 kg										
	3.0 m		4.5 m		6.0 m		7.5 m		9.0 m		10.5 m		12.0 m		13.5 m				m	
																				
12.0 m																		*6740	*6740	9.8
10.5 m									*12540	*12540								*6110	*6110	11.25
9.0 m									*14710	*14710								*5800	*5800	12.26
7.5 m									*15450	15040	*14010	10640						*5680	*5680	12.96
6.0 m					*24680	*24680	*19680	*19680	*16610	14520	14350	10460						*5710	*5710	13.4
4.5 m					*28730	27960	*21930	19230	*17930	13820	13990	10120	*10070	7280				*5880	5650	13.62
3.0 m					*31840	25600	*23880	17970	18030	13110	13570	9720	10290	7140				*6180	5470	13.63
1.5 m					*25760	24140	23630	16990	17380	12490	13190	9360	10130	6990				*6660	5550	13.44
0 m					*29120	23530	22980	16380	16920	12060	12910	9090						*7340	5910	13.02
-1.5 m			*17050	*17050	*31200	23440	22710	16140	16690	11850	12790	8980						*8330	6650	12.37
-3.0 m	*18770	*18770	*28590	*28590	*28530	23720	22780	16200	16720	11870	12900	9080						*9750	7980	11.43
-4.5 m			*29580	*29580	*24460	24310	*19640	16550	*15030	12190										
-6.0 m			*21690	*21690	*18190	*18190	*13910	*13910												

385C Medium Stick – 4400 mm		Shoes – 650 mm				Bucket Capacity – 3.5 m ³				Bucket Weight – 3650 kg										
	3.0 m		4.5 m		6.0 m		7.5 m		9.0 m		10.5 m		12.0 m		13.5 m				m	
																				
12.0 m																		*5530	*5530	10.76
10.5 m																		*5130	*5130	12.05
9.0 m											*11300	*11300						*4940	*4940	12.97
7.5 m									*14890	*14890	*13710	11940						*4900	*4900	13.62
6.0 m							*18710	*18710	*16180	15780	*14440	11640	*11070	8630				*4990	*4990	14.03
4.5 m					*27030	*27030	*21210	20750	*17690	15050	15110	11230	11600	8440				*5190	*5190	14.24
3.0 m					*30980	27850	*23570	19440	*19160	14280	14630	10770	11340	8490				*5520	*5520	14.26
1.5 m					*33480	26030	25000	18320	18480	13580	14170	10330	11080	7930				*6000	5740	14.08
0 m			*13430	*13430	*34300	24980	24150	17520	17900	13040	13800	9980	10870	7730				*6670	6000	13.7
-1.5 m			*19600	*19600	*33680	24540	23670	17090	17540	12700	13560	9750	10770	7630				*7630	6560	13.1
-3.0 m	*18450	*18450	*27550	*27550	*31820	24510	23520	16950	17400	12570	13500	9690						*9040	7540	12.25
-4.5 m	*26750	*26750	*36250	*36250	*28630	24820	*22820	17090	17510	12670	13680	9860								
-6.0 m	*36780	*36780	*29450	*29450	*23690	*23690	*18800	17530	*14090	13090										
-7.5 m					*15860	*15860	*11310	*11310												

385C Long Stick – 5500 mm		Shoes – 650 mm				Bucket Capacity – 3.5 m ³				Bucket Weight – 3650 kg										
	3.0 m		4.5 m		6.0 m		7.5 m		9.0 m		10.5 m		12.0 m		13.5 m				m	
																				
12.0 m																		*3750	*3750	12.16
10.5 m											*8360	*8360						*3460	*3460	13.28
9.0 m											*9790	*9790	*6790	*6790				*3320	*3320	14.11
7.5 m											*11010	*11010	*9050	*9050				*3290	*3290	14.69
6.0 m											*12730	12050	*10740	8980	*5070	*5070	*3360	*3360	15.07	
4.5 m							*18830	*18830	*15990	15570	*14030	11570	11890	8700	*7210	6490	*3510	*3510	15.27	
3.0 m					*27890	*27890	*21540	20200	*17690	14710	14910	11030	11540	8360	*8470	6320	*3760	*3760	15.28	
1.5 m					*31470	27080	*23840	18880	18810	13880	14360	10490	11190	8030	8800	6130	*4110	*4110	15.12	
0 m			*15780	*15780	*33500	25250	24500	17840	18080	13190	13870	10040	10880	7740	*8140	5980	*4620	*4620	14.77	
-1.5 m	*10400	*10400	*19040	*19040	*34010	24640	23750	17150	17550	12690	13510	9690	10660	7520			*5310	*5310	14.23	
-3.0 m	*15630	*15630	*24310	*24310	*33190	24280	23360	16780	17240	12400	13310	9500	10560	7430			*6310	*6310	13.46	
-4.5 m	*21700	*21700	*31490	*31490	*31090	24310	23290	16710	17170	12330	13290	9480								
-6.0 m	*29150	*29150	*35560	*35560	*27490	24680	*21690	16930	*17110	12510	*12840	9700								
-7.5 m	*36440	*36440	*27800	*27800	*21850	*21850	*17010	*17010	*12350	*12350										

 Load Point Height
  Load Radius Over Front
  Load Radius Over Side
  Load at Maximum Reach

* Limited by hydraulic rather than tipping load. The above loads are in compliance with hydraulic excavator lift capacity ratings standard ISO/DIS 10567, they do not exceed 87% of hydraulic lifting capacity or 75% of tipping capacity. Weight of all lifting accessories must be deducted from the above lifting capacities.

Lift Capacities – General Purpose Boom (JB + HB family) 8400 mm

Heavy lift on. All weights are in kg.

	385C L Medium Stick – 3400 mm				Shoes – 750 mm				Bucket Capacity – 3.8 m ³				Bucket Weight – 4500 kg				m
	3.0 m	4.5 m		6.0 m		7.5 m		9.0 m		10.5 m		12.0 m		13.5 m			
12.0 m																	*6740 *6740 9.8
10.5 m								*12 540	*12 540								*6110 *6110 11.25
9.0 m								*14 710	*14 710								*5800 *5800 12.26
7.5 m								*15 450	*15 450	*14 010	11 040						*5680 *5680 12.96
6.0 m					*24 680	*24 680	*19 680	*19 680	*16 610	15 000	*14 560	10 860					*5710 *5710 13.4
4.5 m					*28 730	*28 730	*21 930	19 840	*17 930	14 310	*15 290	10 520	*10 070	7 620			*5880 *5880 13.62
3.0 m					*31 840	26 440	*23 880	18 580	*19 130	13 590	*15 980	10 120	12 810	7 490			*6180 5770 13.63
1.5 m					*25 760	24 980	*25 090	17 600	*19 960	12 980	16 280	9 760	12 640	7 330			*6660 5850 13.44
0 m					*29 120	24 370	*25 370	17 000	*20 210	12 540	15 990	9 490					*7340 6220 13.02
-1.5 m			*17 050	*17 050	*31 200	24 280	*24 650	16 750	*19 700	12 330	*15 740	9 380					*8330 6980 12.37
-3.0 m	*18 770	*18 770	*28 590	*28 590	*28 530	24 560	*22 860	16 810	*18 190	12 360	*13 760	9 480					*9750 8340 11.43
-4.5 m			*29 580	*29 580	*24 460	*24 460	*19 640	17 170	*15 030	12 670							
-6.0 m	*21 690	*21 690	*18 190	*18 190	*13 910	*13 910											

	385C L Medium Stick – 4400 mm				Shoes – 750 mm				Bucket Capacity – 3.5 m ³				Bucket Weight – 3650 kg				m
	3.0 m	4.5 m		6.0 m		7.5 m		9.0 m		10.5 m		12.0 m		13.5 m			
12.0 m																	*5530 *5530 10.76
10.5 m																	*5130 *5130 12.05
9.0 m										*11 300	*11 300						*4940 *4940 12.97
7.5 m								*14 890	*14 890	*13 710	12 340						*4900 *4900 13.62
6.0 m							*18 710	*18 710	*16 180	*16 180	*14 440	12 040	8 970				*4990 *4990 14.03
4.5 m					*27 030	*27 030	*21 210	*21 210	17 690	15 540	*15 350	11 630	*13 670	8 780			*5190 *5190 14.24
3.0 m					*30 980	28 690	*23 570	20 060	*19 160	14 760	*16 240	11 170	13 870	8 530			*5520 *5520 14.26
1.5 m					*33 480	26 870	*25 350	18 940	*20 340	14 060	*16 960	10 730	13 600	8 270			*6000 *6000 14.08
0 m			*13 430	*13 430	*34 300	25 820	*26 260	18 150	*21 010	13 520	16 880	10 380	13 380	8 070			*6670 6300 13.7
-1.5 m			*19 600	*19 600	*33 680	25 380	*26 200	17 710	*21 000	13 180	16 640	10 150	13 270	7 970			*7630 6860 13.1
-3.0 m	*18 450	*18 450	*27 550	*27 550	*31 820	25 350	*25 120	17 570	*20 160	13 050	*16 200	10 090					*9040 7870 12.25
-4.5 m	*26 750	*26 750	*36 250	*36 250	*28 630	25 660	*22 820	17 700	*18 160	13 160	*13 750	10 260					
-6.0 m	*36 780	*36 780	*29 450	*29 450	*23 690	*23 690	*18 800	18 140	*14 090	13 570							
-7.5 m					*15 860	*15 860	*11 310	*11 310									

	385C L Long Stick – 5500 mm				Shoes – 750 mm				Bucket Capacity – 3.5 m ³				Bucket Weight – 3650 kg				m
	3.0 m	4.5 m		6.0 m		7.5 m		9.0 m		10.5 m		12.0 m		13.5 m			
12.0 m																	*3750 *3750 12.16
10.5 m										*8360	*8360						*3460 *3460 13.28
9.0 m										*9790	*9790	*6790	*6790				*3320 *3320 14.11
7.5 m										*11 010	*11 010	*9050	*9050				*3290 *3290 14.69
6.0 m										*12 730	12 450	*10 740	9 320	*5070	*5070	*3360	*3360 15.07
4.5 m							*18 830	*18 830	*15 990	*15 990	*14 030	11 970	*12 550	9 040	*7210	6 780	*3510 *3510 15.27
3.0 m					*27 890	*27 890	*21 540	20 820	*17 690	15 190	*15 130	11 430	*13 280	8 710	*8470	6 610	*3760 *3760 15.28
1.5 m					*31 470	27 920	*23 840	19 490	*19 200	14 370	*16 100	10 890	13 720	8 370	*8970	6 430	*4110 *4110 15.12
0 m			*15 780	*15 780	*33 500	26 360	*25 400	18 450	*20 290	13 670	*16 800	10 440	13 400	8 080	*8140	6 270	*4620 *4620 14.77
-1.5 m	*10 400	*10 400	*19 040	*19 040	*34 010	25 480	*26 060	17 760	*20 800	13 170	16 590	10 090	13 170	7 860			*5310 *5310 14.23
-3.0 m	*15 630	*15 630	*24 310	*24 310	*33 190	25 120	*25 750	17 400	*20 600	12 890	16 380	9 900	13 070	7 770			*6310 *6310 13.46
-4.5 m	*21 700	*21 700	*31 490	*31 490	*31 090	25 150	*24 380	17 330	*19 490	12 820	*15 590	9 880					
-6.0 m	*29 150	*29 150	*35 560	*35 560	*27 490	25 520	*21 690	17 540	*17 110	12 990	*12 840	10 100					
-7.5 m	*36 440	*36 440	*27 800	*27 800	*21 850	*21 850	*17 010	*17 010	*12 350	*12 350							



Load Point Height



Load Radius Over Front



Load Radius Over Side



Load at Maximum Reach

* Limited by hydraulic rather than tipping load.

The above loads are in compliance with hydraulic excavator lift capacity ratings standard ISO/DIS 10567, they do not exceed 87% of hydraulic lifting capacity or 75% of tipping capacity. Weight of all lifting accessories must be deducted from the above lifting capacities.

Lift Capacities – Reach Boom (HB family) 10 000 mm

Heavy lift on. All weights are in kg.

385C Medium Stick – 4400 mm	Shoes – 650 mm								Bucket Capacity – 2.6 m ³				Bucket Weight – 3100 kg				m		
	3.0 m		4.5 m		6.0 m		7.5 m		9.0 m		10.5 m		12.0 m		13.5 m				
13.5 m																	*7090	*7090	11.4
12.0 m											*11 410	*11 410					*6670	*6670	12.82
10.5 m											*11 760	*11 760	9670	9000			*6460	*6460	13.88
9.0 m											*12 170	*12 170	11 210	9050			*6400	5900	14.66
7.5 m									*14 630	*14 630	12 850	11 810	11 570	8850	9210	6510	*6450	5150	15.22
6.0 m					*25 100	*25 100	*19 390	*19 390	*15 970	14 980	13 690	11 240	11 710	8510	9080	6390	*6610	4650	15.58
4.5 m							*21 590	18 740	*17 340	13 930	14 470	10 590	11 290	8110	8860	6180	6500	4330	15.76
3.0 m							*23 340	17 140	*17 840	12 940	13 800	9950	10 860	7700	8610	5930	6330	4160	15.78
1.5 m							22 540	16 000	*16 980	12 130	13 220	9390	10 480	7330	8370	5710	6340	4140	15.62
0 m					*11 420	*11 420	21 830	15 330	16 380	11 560	12 770	8970	10 170	7030	8190	5530	6540	4260	15.28
-1.5 m					*16 880	*16 880	21 510	15 040	16 030	11 240	12 490	8700	9970	6840	8090	5430	6980	4620	14.76
-3.0 m			*14 400	*14 400	*23 870	21 870	21 480	15 010	15 910	11 130	12 370	8590	9910	6780			7730	5200	14.03
-4.5 m	*16 860	*16 860	*21 950	*21 950	*25 030	22 300	*20 880	15 210	16 010	11 210	12 440	8650	10 020	6890					
-6.0 m			*24 890	*24 890	*21 550	*21 550	*18 170	15 610	15 040	11 500	12 050	8920							
-7.5 m					*16 790	*16 790	*14 240	*14 240	*11 410	*11 410									

385C L Medium Stick – 4400 mm	Shoes – 750 mm								Bucket Capacity – 2.6 m ³				Bucket Weight – 3100 kg				m		
	3.0 m		4.5 m		6.0 m		7.5 m		9.0 m		10.5 m		12.0 m		13.5 m				
13.5 m																	*7090	*7090	11.4
12.0 m											*11 410	*11 410					*6670	*6670	12.82
10.5 m											*11 760	*11 760		9350			*6460	*6460	13.88
9.0 m											*12 170	*12 170	*11 210	9350			*6400	6170	14.66
7.5 m									*14 630	*14 630	*12 850	12 210	*11 570	9190	*9710	6810	*6450	5410	15.22
6.0 m					*25 100	*25 100	*19 390	*19 390	*15 970	15 470	*13 690	11 640	*12 070	8850	*10 880	6690	*6610	4900	15.58
4.5 m							*21 590	19 350	*17 340	14 420	*14 570	10 990	*12 620	8450	11 000	6470	*6870	4570	15.76
3.0 m							*23 340	17 750	*18 520	13 420	*15 360	10 350	*13 130	8040	10 740	6230	*7240	4410	15.78
1.5 m							*24 320	16 610	*19 330	12 620	*15 930	9790	12 990	7670	10 490	6000	*7760	4390	15.62
0 m					*11 420	*11 420	*24 480	15 940	*19 660	12 050	15 840	9370	12 680	7370	10 310	5820	8330	4540	15.28
-1.5 m					*16 880	*16 880	*23 930	15 650	*19 460	11 720	15 550	9100	12 480	7190	10 210	5730	8850	4880	14.76
-3.0 m			*14 400	*14 400	*23 870	22 710	*22 740	15 630	*18 700	11 610	15 430	8990	12 410	7120			*8950	5480	14.03
-4.5 m	*16 860	*16 860	*21 950	*21 950	*25 030	23 140	*20 880	15 820	17 300	11 700	*14 240	9050	*11 380	7230					
-6.0 m			*24 890	*24 890	*21 550	*21 550	*18 170	16 230	*15 040	11 990	*12 050	9320							
-7.5 m					*16 790	*16 790	*14 240	*14 240	*11 410	*11 410									

385C L Long Stick – 5500 mm	Shoes – 750 mm								Bucket Capacity – 2.0 m ³				Bucket Weight – 2850 kg				m				
	3.0 m		4.5 m		6.0 m		7.5 m		9.0 m		10.5 m		12.0 m		13.5 m			15.0 m			
13.5 m																		*5340	*5340	12.83	
12.0 m												*7780	*7780					*5040	*5040	14.08	
10.5 m												*9830	*9830					*4880	*4880	15.03	
9.0 m												*10 300	10 010	*8680	7460			*4840	*4840	15.75	
7.5 m										*11 840	*11 840	*10 750	9730	*9930	7350			*4870	4780	16.26	
6.0 m							*14 690	*14 690	*12 750	12 230	*11 340	9330	*10 280	7120	*7100	5320	*4990	4340	16.6		
4.5 m					*26 060	*26 060	*19 880	*19 880	*16 190	15 180	*13 730	11 520	*11 990	8860	*10 680	6830	*8860	5180	*5190	4060	16.77
3.0 m					*21 810	*21 810	*22 010	18 800	*17 580	14 070	*14 670	10 790	*12 610	8380	11 040	6510	8910	5010	*5480	3900	16.78
1.5 m					*14 600	*14 600	*23 540	17 360	*18 690	13 100	*15 440	10 130	*13 130	7920	10 720	6210	8720	4830	*5870	3860	16.64
0 m					*14 770	*14 770	*24 310	16 370	*19 370	12 360	*15 950	9590	12 860	7540	10 450	5960	8570	4680	*6390	3950	16.33
-1.5 m			*8740	*8740	*17 670	*17 670	*24 350	15 800	*19 570	11 860	15 660	9200	12 560	7260	10 250	5770		*7090	4200	15.85	
-3.0 m	*9240	*9240	*13 460	*13 460	*22 260	*22 260	*23 710	15 550	*19 230	11 590	15 420	8970	12 380	7100	10 160	5680		*8040	4630	15.18	
-4.5 m	*14 180	*14 180	*18 890	*18 890	*27 720	22 640	*22 400	15 560	*18 320	11 530	*15 130	8910	12 350	7070	*9920	5730		*8210	5340	14.28	
-6.0 m	*19 690	*19 690	*25 440	*25 440	*24 840	23 090	*20 330	15 790	*16 720	11 670	*13 700	9020	*10 930	7210							
-7.5 m			*25 240	*25 240	*20 920	*20 920	*17 300	16 260	*14 160	12 020	*11 210	9350									
-9.0 m					*15 500	*15 500	*12 820	*12 820	*9990	*9990											

Standard Equipment

Standard equipment may vary. Consult your Caterpillar dealer for specifics.

Electrical

- Alternator – 75 amp
- Lights working
 - Boom, both sides
 - Cab interior
 - Cab mounted, two
 - Frame mounted
 - Storage box mounted
- Signal/warning horn

Engine/Powertrain

- Automatic engine speed control
- Automatic swing parking brake
- Automatic travel parking brakes
- Caterpillar C18 ATAAC with ACERT technology, altitude capability to 2300 m without derating
- Fuel filter
- High ambient cooling, 52°C capability
- Secondary engine shutoff switch
- Side-by-side cooling system with separately mounted AC condenser and variable speed fan
- Two speed travel
- Water separator, with level indicator, for fuel line

Guards

- Heavy duty bottom guards on upper frame
- Heavy duty swivel guard on undercarriage
- Heavy duty travel motor guards on undercarriage

Operator Station

- Adjustable armrest
- Air conditioner, heater and defroster with automatic climate control
- Ashtray and 24 volt lighter
- Beverage/cup holder
- Bolt-on FOGS capability
- Capability to install 2 additional pedals
- Cat walks both side
- Coat hook
- Console mounted electronic type joysticks with adjustable gain and response
- Electrical provision for seat heater
- EU sound criteria package
- Floor mat, washable
- Instrument panel and gauges with full color graphical display, start-up level checks
- Laminated front windshield
- Literature compartment
- Mirrors – left and right
- Neutral lever (lock out) for all controls
- Parallel wiper and washer
- Polycarbonate skylight with sunshade
- Positive filtered ventilation, pressurized cab
- Rear window, emergency exit
- Retractable seat belt 51 mm width
- Sliding upper door window
- Stationary skylight (polycarbonate)
- Storage compartment suitable for lunch box
- Sunscreen (pull down roll type)
- Sunshade for windshield and skylight
- Travel control pedals with removable hand levers
- Windshield wipers and washers (upper and lower)

Track

- Double grouser shoes
 - 385C – 650 mm
 - 385C L – 750 mm
- Grease lubricated track
- Hydraulic track adjusters
- Idler and center section track guards

Undercarriage

- Standard length, variable gauge
- Long length, variable gauge
- Steps – four

Other Standard Equipment

- Auxiliary hydraulic valve for hydro-mechanical tools
- Cat batteries
- Cat brandes XT hoses and reusable couplings
- Cat Datalink and capability to use ET
- Caterpillar one key security system with locks for doors, cab and fuel cap
- Cross-roller type swing bearing
- Drive for auxiliary pump
- Hand control pattern changer
- Heavy lift mode
- Mirrors – left and right
- S•O•SSM quick sampling valves for engine oil and hydraulic oil
- Steel firewall between engine and hydraulic pumps
- Wiring provisions for Product Link, Auto-lube System and lighted beacon

Optional Equipment

Optional equipment may vary. Consult your Caterpillar dealer for specifics.

Front Linkage

Bucket linkages

JB-family for JB sticks (available with or without lifting eye)

HB-family for HB sticks (available with or without lifting eye)

Buckets – see chart pg.13

Booms (with two working lights)

Mass excavation

– 7250 mm

General purpose

– 8400 mm

Reach

– 10 000 mm

Sticks

For mass boom

– M2.9JB

– M3.4JB

For general purpose boom

– G3.4JB

– G/R4.4HB

– G/R5.5HB

For reach boom

– G/R4.4HB

– G/R5.5HB

Tips, sidecutters and edge protectors

Track

Double grouser

– 650 mm (for 385C L)

– 750 mm (for 385C)

– 900 mm (385C L only)

Guards

Bucket cylinder quarry

FOGS (Falling Object Guard System) including overhead and windshield guards

Track guiding guards

– Full length

– Additional segment at idler end and sprocket end

Wire mesh screen for windshield

Auxiliary Controls and Lines

Auxiliary boom lines

– high pressure for reach, general purpose and mass booms

– medium pressure for reach, general purpose and mass booms

Auxiliary stick lines

– high pressure for reach, general purpose and mass sticks

– medium pressure for reach, general purpose and mass sticks

Basic control arrangements

Single action – one way high pressure circuit for hammer application

Tool Control

Combined function – one way high pressure circuit for hammer application function for 1-way

or 2-way high pressure

Medium pressure circuit

Tool selection (via monitor 5 tools)

Miscellaneous Options

Bio hydraulic oil package

Boom lowering control device with

SmartBoom

Cab front rain protector

Converters, 7 amp-12V

– One

– Two

Counterweight removal system

Electric refueling pump with auto shut-off

Fast fill fuel system

Fine filtration filter

Hydraulic tank shut-off valve

Jump start terminals

Product Link

Radiator screen

Reversible cooling fan including protective screen

Starting aid for cold weather with ether

Stick lowering control device

Travel alarm with cut off switch

Operator Compartment

Joysticks

Four button joystick for standard machine or single action auxiliary control

Thumb wheel modulation joystick for use with combined auxiliary control

Lunch box storage with lid

Machine security system with programmable keys

Pedal

Auxiliary hydraulics (left side)

Straight travel (right side)

Radio

AM/FM radio mounted in right hand console with antenna and two speakers

Radio ready mounting at rear location including 24V to 12V converter speakers, antenna

Seat

Adjustable high-back seat with mechanical suspension

Adjustable high-back seat with air suspension

Adjustable high-back heated seat with air suspension

Windshield

1-piece standard duty

1-piece high impact resistant

50-50 split, sliding

70-30 split, sliding

385C and 385C L Hydraulic Excavators

For more complete information on Cat products, dealer services, and industry solutions, visit us on the web at www.cat.com

Materials and specifications are subject to change without notice. Featured machines in photos may include additional equipment. See your Caterpillar dealer for available options.

© 2007 Caterpillar -- All rights reserved

CAT, CATERPILLAR, their respective logos, "Caterpillar Yellow" and the POWER EDGE trade dress as well as corporate and product identity used herein, are trademarks of Caterpillar and may not be used without permission.

HEHH3115-1 (07/2005) hr

CATERPILLAR[®]